

25. ASSEMBLY STOP OIL PLATE - MODEL 9 x 7 NL

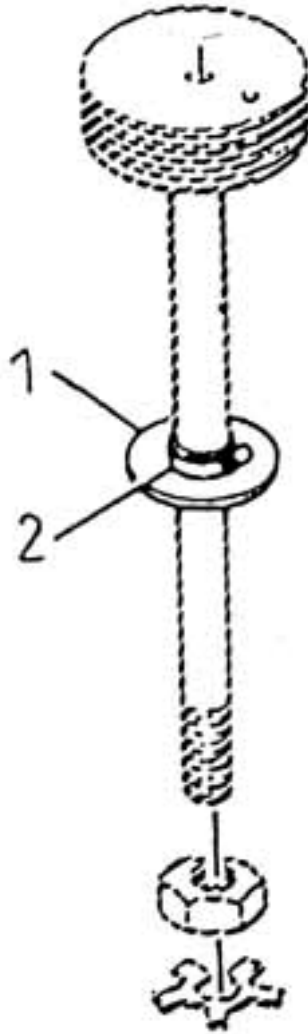

All manufacturer's names, numbers, photos, product description and/or part numbers are used for reference purposes only & it is not implied that any part listed is the product of these manufacturers. Since Approvement are made from time to time, the illustration and specifications are subject to change without notice.

25. ASSEMBLY STOP OIL PLATE - MODEL 9 x 7 NL

No.	Description	Ref Part No.	QTY
–	Assembly Stop Oil Plate	70325246	–
1	– Stop Oil Plate	30253025	1
2	– Clamp	95235131	1