

20. ASSEMBLY VALVE INLET & UNLOADER - MODEL 7 x 5 LUB

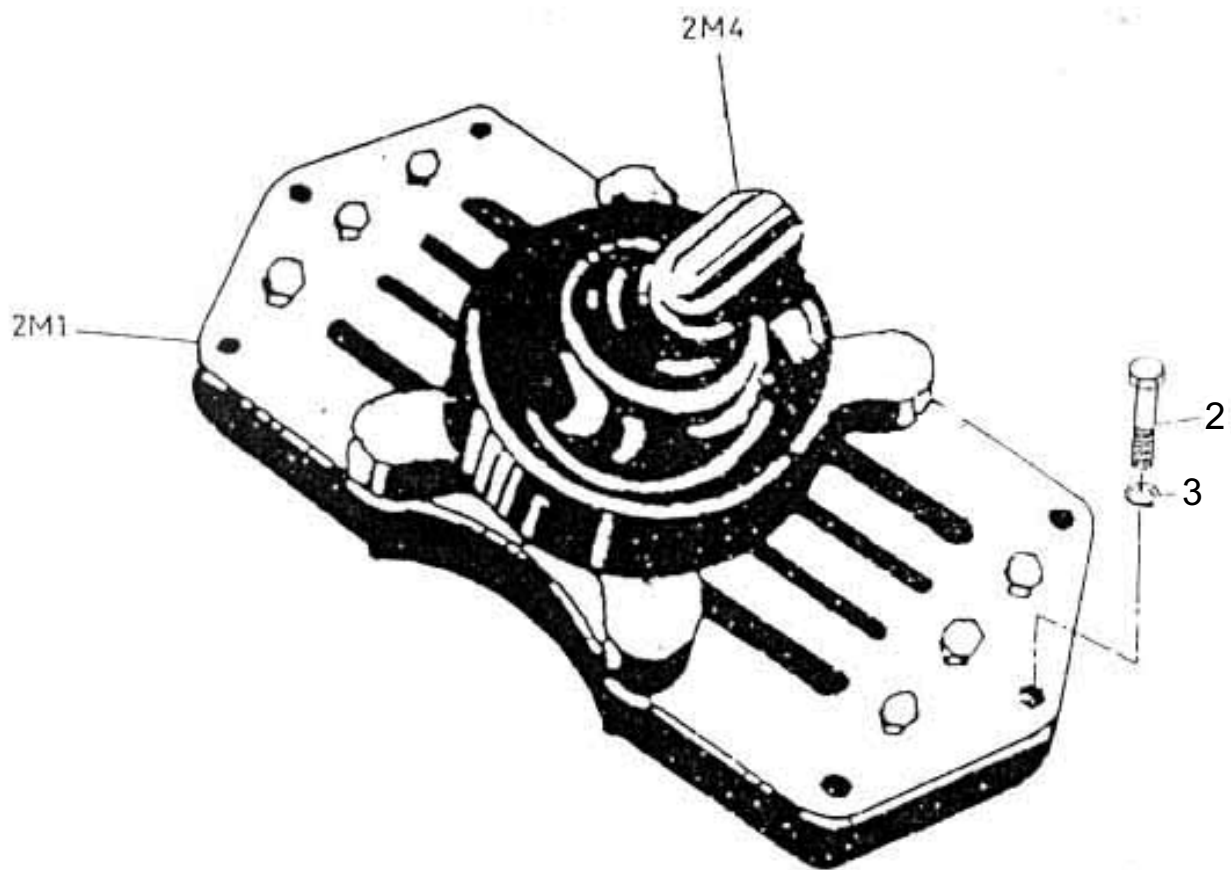

All manufacturer's names, numbers, photos, product description and/or part numbers are used for reference purposes only & it is not implied that any part listed is the product of these manufacturers. Since Approvement are made from time to time, the illustration and specifications are subject to change without notice.

20. ASSEMBLY VALVE INLET & UNLOADER - MODEL 7 x 5 LUB

No.	Description	Ref Part No.	QTY
–	Assembly Valve Inlet & Unloader	94485471	–
2M1	– Valve Inlet	37020260	1
2	– Bolt Hex Head 5/16" X 1-1/4"	95002978	6
3	– Washer Spring 5/16"	95096145	6
2M4	– Assembly Unloader	70265434	1