

37021565 - ASSEMBLY VALVE INLET

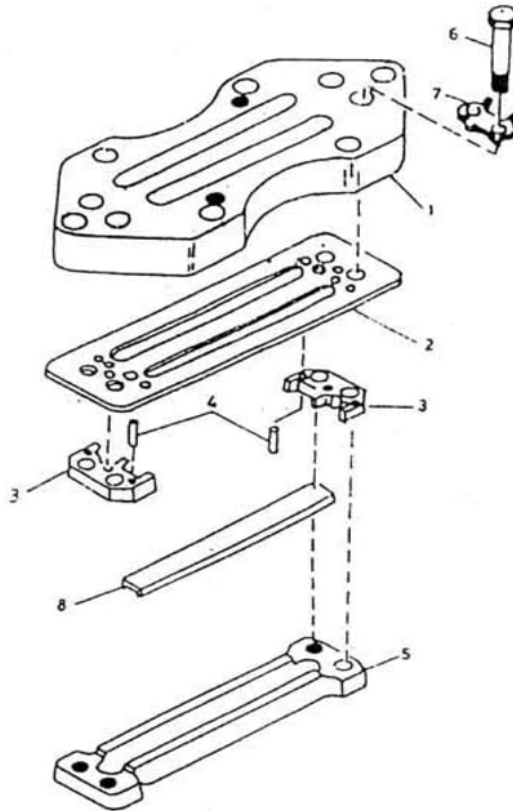

No.	Description	Ref Part No.	QTY
-	ASSEMBLY VALVE INLET	37021565	-
1	- SEAT VALVE	30253405	1
2	- SEAT VALVE	37021581IM	1
3	- GUIDE VALVE	37021573IM	2
4	- PIN DRIVE LOCK 1/8" X 9/16"	70233101	4
5	- STOP PLATE	30252951	1
6	- BOLT HEX HEAD 1/4" X 1-1/2"	95105466	6
7	- WASHER LOCK	31225485	2
8	- CHANNEL & SPRING SET	30514624IM	1

All manufacturer's names, numbers, photos, product description and/or part numbers are used for reference purposes only & it is not implied that any part listed is the product of these manufacturers. Since Approvement are made from time to time, the illustration and specifications are subject to change without notice.