

16. ASSEMBLY HEAD FRAME & DIST. PIECE - MODEL 8 x 7 NL

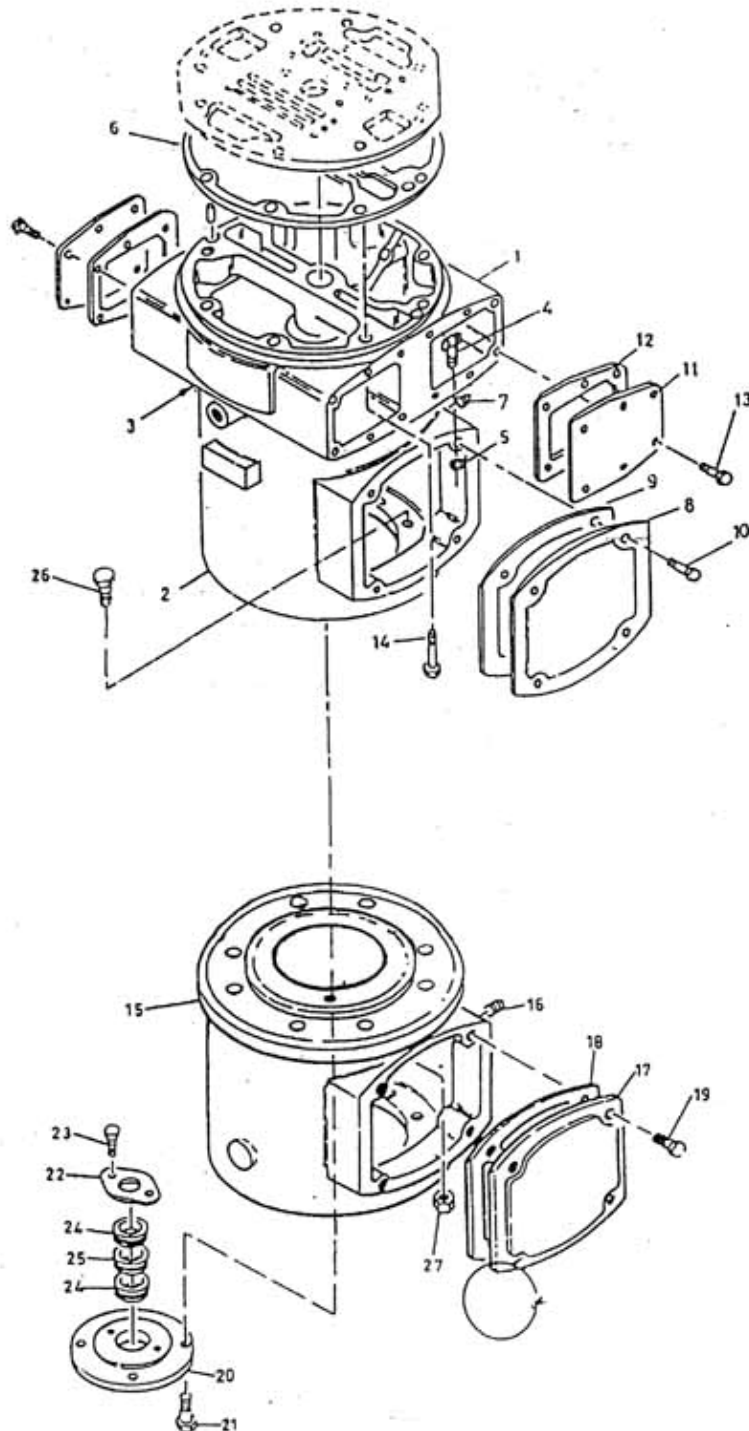

All manufacturer's names, numbers, photos, product description and/or part numbers are used for reference purposes only & it is not implied that any part listed is the product of these manufacturers. Since Approvement are made from time to time, the illustration and specifications are subject to change without notice.

16. ASSEMBLY HEAD FRAME & DIST. PIECE - MODEL 8 x 7 NL

No.	Description	Ref Part No.	QTY
–	Assembly Head Frame & Dist. Piece	70430384	–
1	– Head Frame	42007245	1
2	– Distance Piece	42002840	1
3	– Gasket Distance Piece	40514507	1
4	– Stud 3/4" X 3 -1/4"	95737417	8
5	– Nut Hex 3/4"	95077822	8
6	– Gasket Frame Head	39542113	1
7	– Plug Pipe Sq. Hd 1/4"	95033593	1
8	– Cover Distance Piece	39878046	1
9	– Gasket Cover Distance Piece	30562664	1
10	– Screw Cap Hex 1/2" X1"	95104147	4
11	– Cover Valve	37087954	4
12	– Gasket Cover	39486030	4
13	– Screw Cap Hex 1/2" X1"	95104147	24
14	– Screw Cap Frame Head	30556963	8
15	– Distance Piece	30566699	1
16	– Plug Pipe Sq. Hd 1/2"	95033649	1
17	– Cover Distance Piece	39878046	1
18	– Gasket Cover Distance Piece	30562664	1
19	– Screw Cap Hex 1/2" X 1"	95104147	4
20	– Stuffing Box	37085933	1
21	– Screw Cap Hex 3/8" X 1"	95035333	4
22	– Plate Partition Scrpr	37087988	1
23	– Screw Cap Hex Head 3/8" X 3/4"	95103743	2
24	– Ring Scrapper	95009197IM	2
25	– Ring Scrapper	95045936IM	1
26	– Screw Cap Hex Head 3/4" X 2- 3/4"	95104659	8
27	– Nut Hex 3/4"	95077822	8

All manufacturer's names, numbers, photos, product description and/or part numbers are used for reference purposes only & it is not implied that any part listed is the product of these manufacturers. Since Approvement are made from time to time, the illustration and specifications are subject to change without notice.