

32146052* - CRANKSHAFT COMPLETE WITH BUSHING

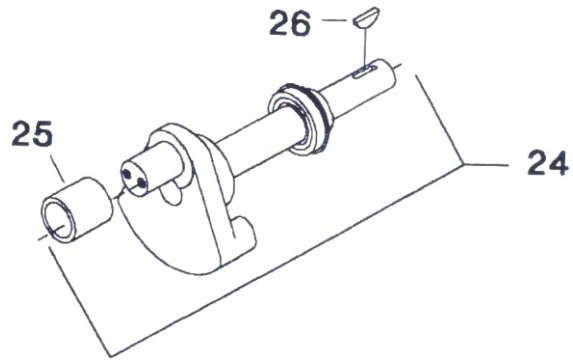

No.	Description	Ref Part No.	QTY
1-24	Crankshaft Complete With Bushing	32146052*	-
1-25	- Bushing, Crankpin	30210199	1
1-26	- Key, Woodruff	95433173	1