

24. VALVE DISCHARGE - MODEL 8 x 5 LUB

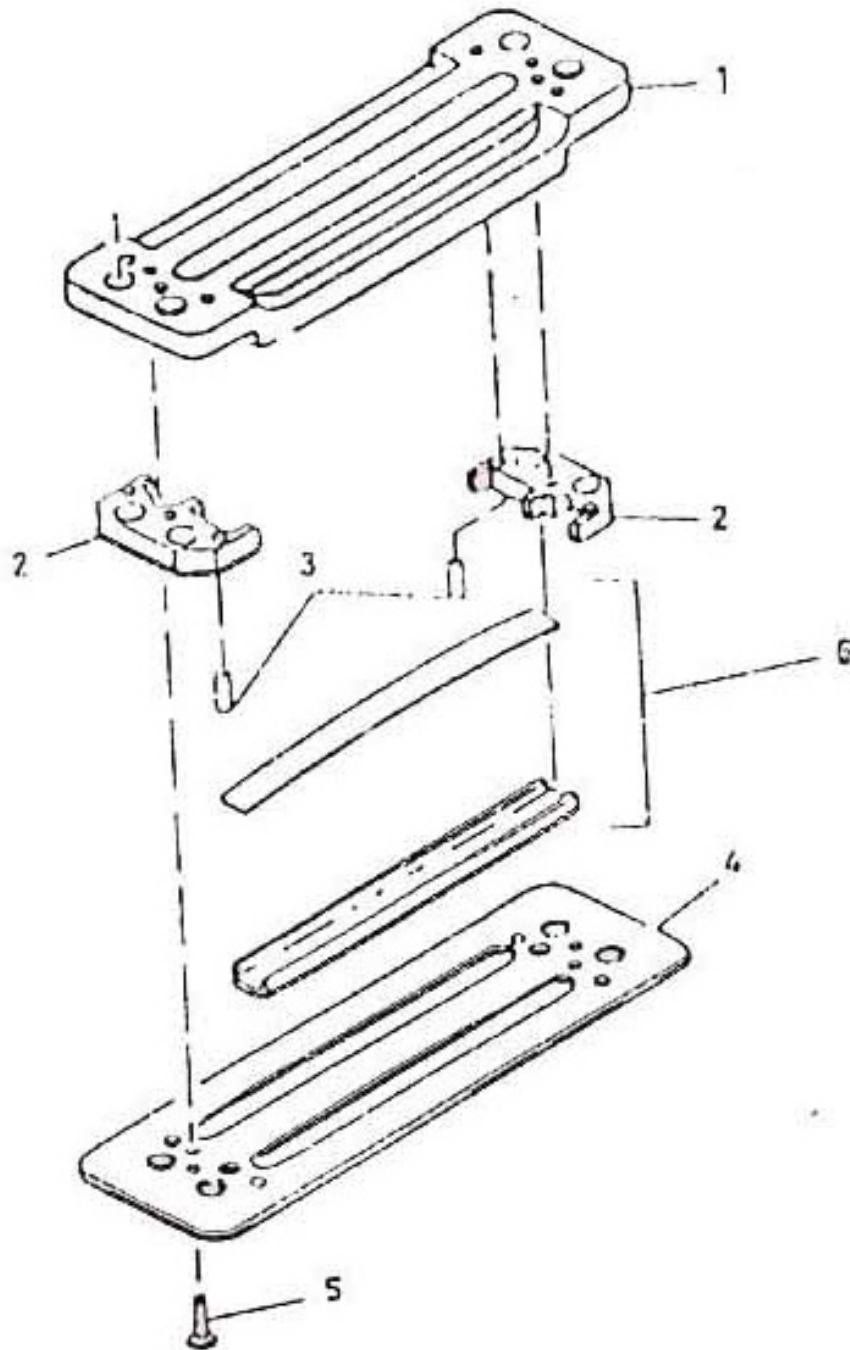

All manufacturer's names, numbers, photos, product description and/or part numbers are used for reference purposes only & it is not implied that any part listed is the product of these manufacturers. Since Approvement are made from time to time, the illustration and specifications are subject to change without notice.

24. VALVE DISCHARGE - MODEL 8 x 5 LUB

No.	Description	Ref Part No.	QTY
–	Valve Discharge	37020575	–
1	– Stop Plate	37074721	1
2	– Guide Valve	37020559IM	2
3	– Pin Drive Lock 1/8" X 9/16"	70233101	4
4	– Seat Plate	37020567IM	1
5	– Screw Machine	95110763	2
6	– Channel & Spring Set	37020609IM	1
–	Guide Center	–	1