

10. ASSEMBLY CROSS HEAD - MODEL 8 x 5 NL

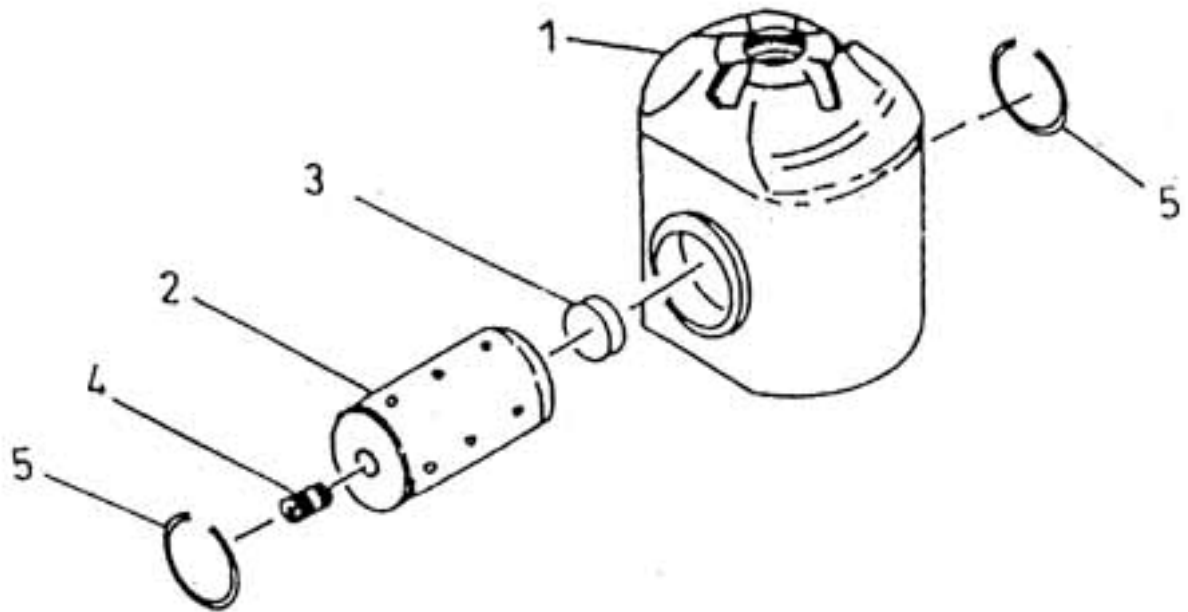

10. ASSEMBLY CROSS HEAD - MODEL 8 x 5 NL

No.	Description	Ref Part No.	QTY
1	Cross Head 5"	30559728	1
2	Pin Crosshead	34579342	1
3	Plug Crosshead Pin	30569008	1
4	Plug 1/4"	95250932	1
5	Ring Retainer	30576144IM	2