

## 10. ASSEMBLY CROSS HEAD - MODEL 7 x 5 LUB

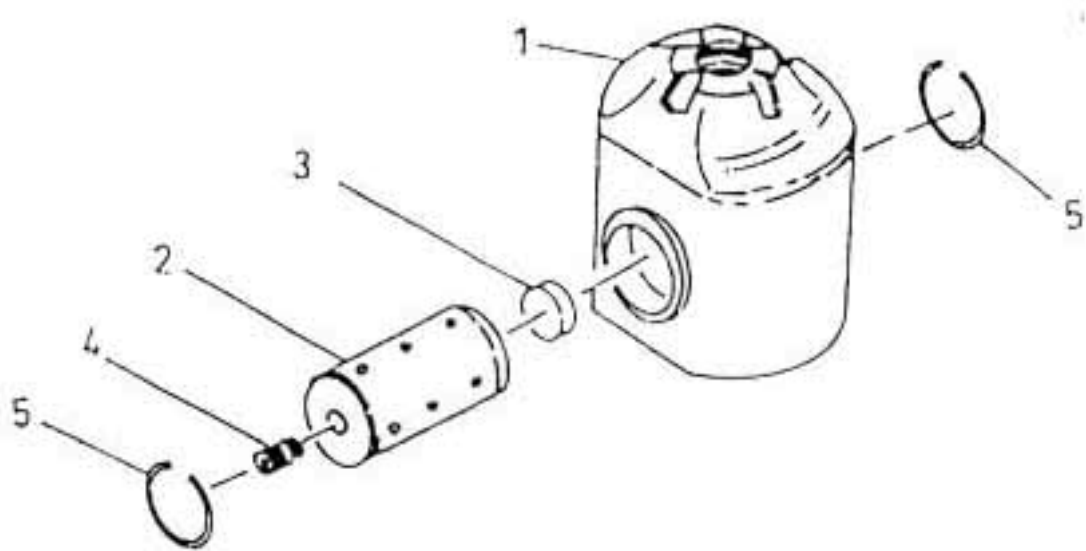

All manufacturer's names, numbers, photos, product description and/or part numbers are used for reference purposes only & it is not implied that any part listed is the product of these manufacturers. Since Approvement are made from time to time, the illustration and specifications are subject to change without notice.

## 10. ASSEMBLY CROSS HEAD - MODEL 7 x 5 LUB

No.	Description	Ref Part No.	QTY
1	Cross Head 5"	30559728	1
2	Pin Crosshead	34579342	1
3	Plug Crosshead Pin	30569008	1
4	Plug 1/4"	95250932	1
5	Ring Retainer	30576144IM	2